

FireKing









2.000

0.031



1.807

FILES

- 2 FIREKING® VERTICAL/FIREKING LATERAL FILES 
- 3 FIREKING 25° 
- 3 FIREKING TURTLE® 
- 4 FIREKING PROTECTION PLUS™ 
- 4 FIREKING TWO-HOUR VERTICAL FILES 
- 5 FIREKING CARD, CHECK AND NOTE FILES 
- 5 FIREKING MEDIAVAULT™ 

SAFES

- 10 UL® 1-HOUR FIRE SAFES/UL 2-HOUR FIRE SAFES 
- 11 UL 1-HOUR FIRE AND BURGLARY SAFES 
- 12 UL 2-HOUR FIRE WITH IMPACT AND BURGLARY SAFES 
- 13 FIREKING MIXED MEDIA SAFE 
- 14 FIREKING THREE-HOUR DATA SAFES 
- 15 FIREKING TWO-HOUR DATA SAFES 
- 16 FIREKING ONE-HOUR DATA SAFE 

SPECS

- 6 FIREKING FILE SPECIFICATIONS
- 7 COLORS AND FEATURES
- 10 UL 1-HOUR FIRE SAFES/UL 2-HOUR FIRE SAFES SPECIFICATIONS
- 11 UL 1-HOUR FIRE AND BURGLARY SAFES SPECIFICATIONS
- 12 UL 2-HOUR FIRE WITH IMPACT AND BURGLARY SAFES SPECIFICATIONS
- 13 FIREKING MIXED MEDIA SAFE SPECIFICATIONS
- 14 FIREKING THREE-HOUR DATA SAFE SPECIFICATIONS
- 15 FIREKING TWO-HOUR DATA SAFE SPECIFICATIONS
- 16 FIREKING ONE-HOUR DATA SAFE SPECIFICATIONS
- 17 FIREKING MEDIAVAULT™ SPECIFICATIONS

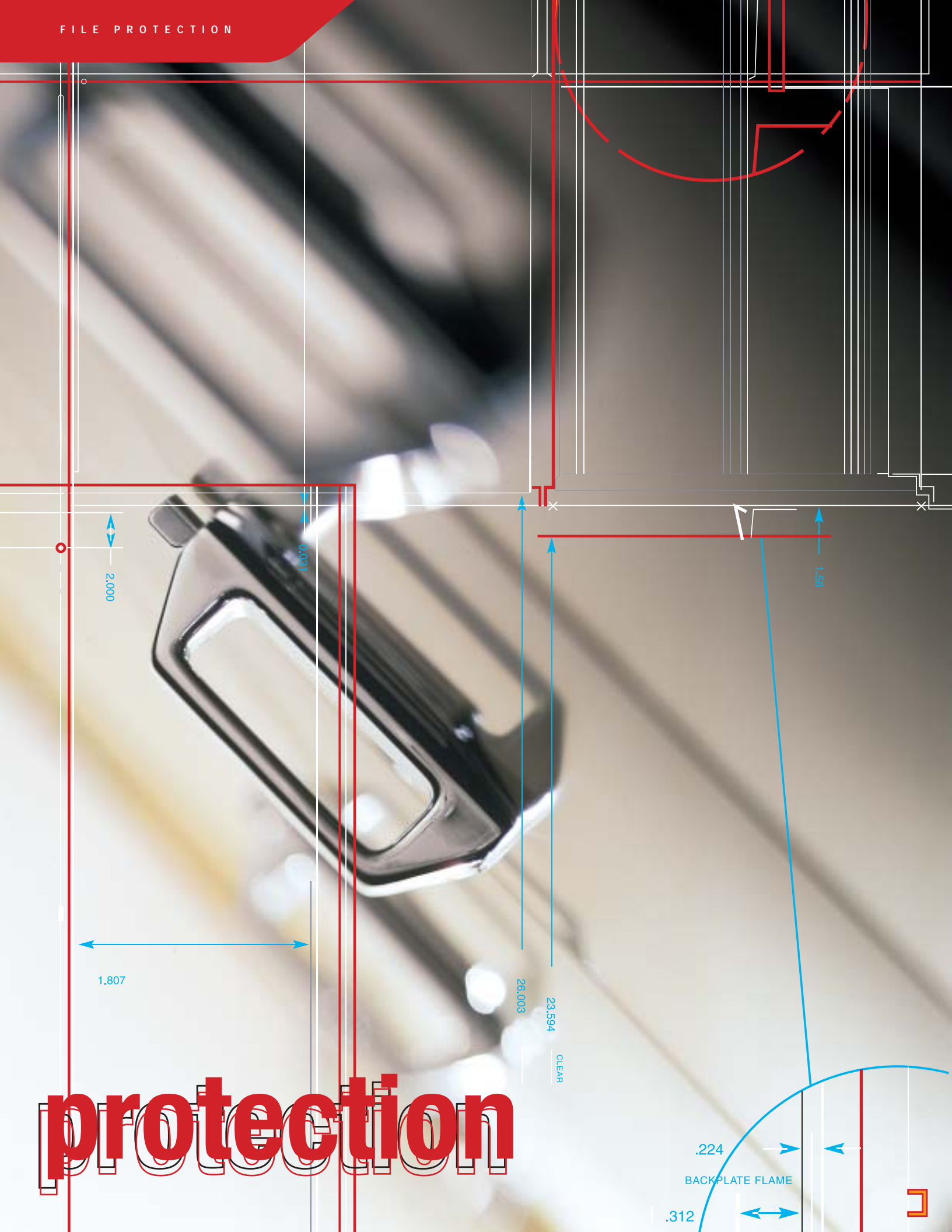

2.000

0.031

1.807

26.003

23.594

CLEAR

1.538

.224

BACKPLATE FLAME

.312

protection



What are your most important documents? How would losing these documents affect your business? What are you doing to protect them?



THE RIGHT FIREPROOF FILE IS NOT JUST THE ANSWER. IT'S A SERIES OF QUESTIONS.

Tax records. Customer lists. Accounts payable and receivable. Insurance policies. Computer records. Deeds, titles and licenses. Before you can decide how to best protect them, you need to ask yourself some hard questions.

But there's one question you don't have to ask: What brand of fireproof file should I buy?

Fire King has been building fireproof files of unsurpassed quality for over 50 years. Our state-of-the-art manufacturing facility builds tens of thousands of FireKing files for business, government, financial and personal use every year.

Our files carry the prestigious Underwriters Laboratories® (UL)® Class 350 1-hour Insulated Records Container with impact rating; meaning they have passed the UL 1700° fire endurance test, 2000° explosion hazard test, and 30-foot drop/impact test. And, we also offer the industry's only UL-rated 2-hour file.

The quality built into every FireKing file cabinet is the very best. We back up our quality claims with a lifetime product warranty and free replacement guarantee.

Our *lifetime warranty* on all mechanical or operable parts ensures that if a part malfunctions or breaks down during normal use, we will either repair or replace the part. Associated labor costs for the repair or replacement of these parts will be paid by Fire King for two years from the date of purchase.

With our *free replacement guarantee*, if a FireKing file cabinet sustains any damage while protecting records from a fire, we will replace it free of charge.

For protecting your valuable information and your peace of mind, FireKing files are the best records protection you can buy.

FireKing vertical files offer great protection for a modest investment.

FireKing lateral files offer increased capacity and contemporary design.



4 - 2131 - C
Legal Size/Shown in parchment

2 - 2131 - C



4 - 3822 - C
Shown in black

2 - 3822 - C

FIREKING VERTICAL FILES

FireKing vertical 31" deep files add a lot of protection to any office. For a modest one-time investment, you'll rest easier knowing that FireKing's most popular fireproof files are protecting your business. Vertical files are available in 2-, 3- and 4-drawer sizes, as well as letter and legal widths. A UL-listed high security Medeco® lock is standard. A variety of additional locking options are available. Choose from nine standard colors (or any custom color you specify) to match your office décor perfectly. A complete range of accessory and interior options are also offered. Keep your records safe and on-hand with UL Class 350 1-hour fire protection that carries Fire King's lifetime warranty. The exact style you want and the peace of mind you need.

FIREKING LATERAL FILES

Our lateral files offer you all the features of our vertical files in a sleek design. They're fully equipped to handle both letter and legal hanging files—no additional frames are required. They're available in 31", 38" and 44" widths in 2-, 3- and 4-drawer sizes, with a UL-listed Medeco key lock. Additional locking options are available. And like our vertical files, they're available in nine standard colors or any custom color you specify. Peace of mind that fits your office and your sense of style.

When space and budget are at a premium, these 25" deep files are a perfect fit.

FireKing's most economical files. The 22"-deep Turtle is perfect for the small business or home office.



4 - 2125 - C
Legal size/Shown in platinum



2 - 2125 - C
Legal size



4R1822 - C
Shown in parchment



2R1822 - C
Shown in parchment

Also available in lateral.

Letter- and legal-sized documents can be filed in a Turtle.

- Letter - front to back
- Legal - side to side

FIREKING 25®

FireKing 25 files provide your important records with the protection they need while economizing your space and budget. All the benefits of our larger-sized FireKing files in a competitively priced, 25" deep size. Available in 2- or 4-drawer models and letter or legal widths. All FireKing 25 files are equipped with a UL-listed, high-security Medeco key lock. Four standard colors are available: black, sand, parchment and platinum.

FIREKING TURTLE®

Don't spend money duplicating or replacing your valuable records. Just get a Turtle. For safeguarding your irreplaceable records and documents, no other 22" deep file gives you as much protection as the extra-tough Turtle from FireKing. Both letter and legal-sized documents can be filed in a Turtle. The Turtle offers UL 1-hour fire protection with impact rating. Each one comes with a standard 4-pin key lock and our exclusive lifetime warranty. It's perfect for your home, personal office or small business. Available in parchment color only. A lifetime of security at one affordable price. Also available in a sleek 2-drawer lateral for two rows of front-to-back letter filing, one row of side-to-side filing, or a combination of letter and legal filing.

When added security is needed, FireKing Protection Plus files offer a concealed safe in the top drawer or a file with an electronic lock.

When added protection is needed for high-risk fire areas, a FireKing Two-Hour file is the answer.

SAFE-IN-A-FILE
4-2131-CSF
Shown in parchment

ELECTRONIC LOCK FILE
4-2131-CEL
Shown in parchment

TWO-HOUR FILE
4-2157-2
Shown in parchment



Protection Plus with combination lock.



Protection Plus Safe-In-A-File



3 file drawers



FIREKING PROTECTION PLUS™

For additional security, we offer the Protection Plus Safe-In-A-File and the Protection Plus Electronic Lock File. The exterior is available in nine standard colors.

Protection Plus Safe-In-A-File Features

- 2.4 cubic foot capacity
- Inner safe door constructed of 1/4" steel
- Safe features internal relocking device
- Both safe and file drawers offer fireproof protection
- UL-listed Group II combination lock
- Safe interiors are available in parchment or platinum

Protection Plus Electronic Lock File Features

- Six-digit combination code for quick opening
- Master code and up to eight different user codes
- User code can be changed or deleted in seconds
- Drawers lock automatically when closed to ensure document security
- UL-listed Group II combination lock with internal relocking device

FIREKING TWO-HOUR VERTICAL FILES

The ultimate in fireproof records protection. These are the only American-built insulated files with a 2-hour fire and impact rating from Underwriters Laboratories. That's because they are made with Thermocell II® a proprietary insulation which provides twice the protection. Available in both letter and legal sizes. A UL-listed, high-security Medeco key lock comes standard. Nine standard colors to choose from. Vertical files also come in custom colors and are available in 2-, 3- or 4-drawer models.

Primarily used in banks, these Card, Check and Note files offer flexibility for unique filing requirements.

The FireKing MediaVault protects all types of computer media.

**CARD, CHECK
AND NOTE FILE**
6-2552-C
Shown in parchment



Shown with 32026 Inserts (sold separately)

4-2536-C



MV1000



MV1000
Outside Dimensions:
10½" H x 11½" W x 17½" D
Inside Dimensions:
5½" H x 6¼" W x 8¾" D
Approx. Shipping Weight 74 lbs.

MV1000

Capacity: MV1000	130 - 3½" Diskette	23 - Travan
	120 - 5¼" Diskette	23 - CD-ROM
	60 - 4mm DAT	+12 - DLT
	32 - DC 2000/2120	9 - 3480/3590
	30 - 8mm DAT	31 - Iomega Zip 100

FireKing 1-Hour UL Class 125 Fire Rating.
*Without plastic sleeves.

FIREKING CARD, CHECK AND NOTE FILES

Available in 4- and 6-drawer models. All models come with a UL 1-hour fire and impact rating. All Card, Check and Note files feature a UL-listed, high-security Medeco key lock. A wide variety of additional locking options are available to secure confidentiality. Plus, these files offer the option of 2- or 3-section inserts and card trays to allow you the flexibility your filing systems require. They come in nine standard colors or any custom color you specify.

FIREKING MEDIAVAULT™

Your sensitive electronic records need special protection from heat, humidity, and fire that could damage irreplaceable data. The MediaVault from FireKing is the stand-alone storage safe that gives your CDs, tapes, diskettes, microfiche and data cartridges the treatment they need. MediaVault is the only affordable media safe of its size to meet UL Class 125, 1-hour specification for insulated record protection. Total peace of mind at an affordable price.

Specifications

	Catalog No.	Description	Inside Dimensions			Outside Dimensions			Approx. Shipping Weight
			H	W	D	H	W	D	
FIREKING TWO-HOUR VERTICAL FILES	4-1956-2	4 Drawer Letter	11 ⁷ / ₁₆ "	12 ¹ / ₁₆ "	25 ¹ / ₁₆ "	56 ³ / ₁₆ "	18 ³ / ₁₆ "	31 ¹ / ₁₆ "	837 lbs.
	4-2157-2	4 Drawer Legal	11 ²⁵ / ₃₂ "	15 ¹ / ₄ "	26"	57"	21 ⁹ / ₁₆ "	32 ¹ / ₁₆ "	900 lbs.
	3-1943-2	3 Drawer Letter	11 ⁹ / ₁₆ "	12 ³ / ₁₆ "	25 ¹ / ₁₆ "	42 ³ / ₁₆ "	18 ³ / ₁₆ "	31 ¹ / ₁₆ "	674 lbs.
	3-2144-2	3 Drawer Legal	11 ²⁵ / ₃₂ "	15 ¹ / ₄ "	26"	43 ¹ / ₁₆ "	21 ⁹ / ₁₆ "	32 ¹ / ₁₆ "	792 lbs.
	2-1929-2	2 Drawer Letter	11 ⁷ / ₁₆ "	12 ¹ / ₁₆ "	25 ¹ / ₁₆ "	29 ⁹ / ₃₂ "	18 ³ / ₁₆ "	31 ¹ / ₁₆ "	482 lbs.
	2-2130-2	2 Drawer Legal	11 ²⁵ / ₃₂ "	15 ¹ / ₄ "	26"	29 ⁷ / ₁₆ "	21 ⁹ / ₁₆ "	32 ¹ / ₁₆ "	513 lbs.
FIREKING VERTICAL FILES	4-1831-C	4 Drawer Letter	10 ³ / ₁₆ "	12 ¹ / ₁₆ "	26"	52 ¹ / ₁₆ "	17 ³ / ₄ "	31 ¹ / ₁₆ "	650 lbs.
	4-2131-C	4 Drawer Legal	10 ³ / ₁₆ "	15 ¹ / ₄ "	26"	52 ¹ / ₁₆ "	20 ¹³ / ₁₆ "	31 ¹ / ₁₆ "	710 lbs.
	3-1831-C	3 Drawer Letter	10 ³ / ₁₆ "	12 ¹ / ₁₆ "	26"	40 ¹ / ₄ "	17 ³ / ₄ "	31 ¹ / ₁₆ "	504 lbs.
	3-2131-C	3 Drawer Legal	10 ³ / ₁₆ "	15 ¹ / ₄ "	26"	40 ¹ / ₄ "	20 ¹³ / ₁₆ "	31 ¹ / ₁₆ "	565 lbs.
	2-1831-C	2 Drawer Letter	10 ³ / ₁₆ "	12 ¹ / ₁₆ "	26"	27 ³ / ₄ "	17 ³ / ₄ "	31 ¹ / ₁₆ "	374 lbs.
	2-2131-C	2 Drawer Legal	10 ³ / ₁₆ "	15 ¹ / ₄ "	26"	27 ³ / ₄ "	20 ¹³ / ₁₆ "	31 ¹ / ₁₆ "	408 lbs.
FIREKING LATERAL FILES	4-3122-C	4 Drawer	10 ³ / ₁₆ "	25 ¹ / ₁₆ "	15 ¹ / ₁₆ "	52 ¹ / ₁₆ "	31 ³ / ₁₆ "	22 ¹ / ₁₆ "	750 lbs.
	4-3822-C	4 Drawer	10 ³ / ₁₆ "	31 ²⁹ / ₃₂ "	15 ¹ / ₁₆ "	52 ¹ / ₁₆ "	37 ¹⁵ / ₃₂ "	22 ¹ / ₁₆ "	900 lbs.
	4-4422-C	4 Drawer	10 ³ / ₁₆ "	38 ²⁹ / ₃₂ "	15 ¹ / ₁₆ "	52 ¹ / ₁₆ "	44 ¹⁵ / ₃₂ "	22 ¹ / ₁₆ "	1,022 lbs.
	3-3122-C	3 Drawer	10 ³ / ₁₆ "	25 ¹ / ₁₆ "	15 ¹ / ₁₆ "	40 ¹ / ₄ "	31 ³ / ₁₆ "	22 ¹ / ₁₆ "	600 lbs.
	3-3822-C	3 Drawer	10 ³ / ₁₆ "	31 ²⁹ / ₃₂ "	15 ¹ / ₁₆ "	40 ¹ / ₄ "	37 ¹⁵ / ₃₂ "	22 ¹ / ₁₆ "	732 lbs.
	3-4422-C	3 Drawer	10 ³ / ₁₆ "	38 ²⁹ / ₃₂ "	15 ¹ / ₁₆ "	40 ¹ / ₄ "	44 ¹⁵ / ₃₂ "	22 ¹ / ₁₆ "	809 lbs.
	2-3122-C	2 Drawer	10 ³ / ₁₆ "	25 ¹ / ₁₆ "	15 ¹ / ₁₆ "	27 ³ / ₄ "	31 ³ / ₁₆ "	22 ¹ / ₁₆ "	455 lbs.
	2-3822-C	2 Drawer	10 ³ / ₁₆ "	31 ²⁹ / ₃₂ "	15 ¹ / ₁₆ "	27 ³ / ₄ "	37 ¹⁵ / ₃₂ "	22 ¹ / ₁₆ "	557 lbs.
	2-4422-C	2 Drawer	10 ³ / ₁₆ "	38 ²⁹ / ₃₂ "	15 ¹ / ₁₆ "	27 ³ / ₄ "	44 ¹⁵ / ₃₂ "	22 ¹ / ₁₆ "	617 lbs.
	<i>Laterals: Multi-purpose lateral files designed for letter and legal filing. Fully equipped for letter and legal hanging folders.</i>								
FIREKING PROTECTION PLUS FILES	4-2131-C SF	4 Dr Legal Safe-In-A-File	10 ³ / ₁₆ "	15 ¹ / ₄ "	26"	52 ¹ / ₁₆ "	20 ¹³ / ₁₆ "	31 ¹ / ₁₆ "	782 lbs.
	3-2131-C SF	3 Dr Legal Safe-In-A-File	10 ³ / ₁₆ "	15 ¹ / ₄ "	26"	40 ¹ / ₄ "	20 ¹³ / ₁₆ "	31 ¹ / ₁₆ "	649 lbs.
	2-2131-C SF	2 Dr Legal Safe-In-A-File	10 ³ / ₁₆ "	15 ¹ / ₄ "	26"	27 ³ / ₄ "	20 ¹³ / ₁₆ "	31 ¹ / ₁₆ "	507 lbs.
	4-1831-C EL	4 Dr Letter Elec. Lock File	10 ³ / ₁₆ "	12 ¹ / ₁₆ "	26"	52 ¹ / ₁₆ "	17 ³ / ₄ "	31 ¹ / ₁₆ "	650 lbs.
	4-2131-C EL	4 Dr Legal Elec. Lock File	10 ³ / ₁₆ "	15 ¹ / ₄ "	26"	52 ¹ / ₁₆ "	20 ¹³ / ₁₆ "	31 ¹ / ₁₆ "	710 lbs.
	<i>Safe-In-A-File: Safe inside dimensions - 10³/₁₆" h, 16¹/₄" w, 24³/₈" d. Safe interiors available only in parchment and platinum.</i>								
FIREKING 25	4-1825-C	4 Dr Letter 25" Deep	10 ³ / ₁₆ "	12 ¹ / ₁₆ "	19 ³ / ₄ "	52 ¹ / ₁₆ "	17 ³ / ₄ "	25 ¹ / ₁₆ "	546 lbs.
	4-2125-C	4 Dr Legal 25" Deep	10 ³ / ₁₆ "	15 ¹ / ₄ "	19 ³ / ₄ "	52 ¹ / ₁₆ "	20 ¹³ / ₁₆ "	25 ¹ / ₁₆ "	596 lbs.
	2-1825-C	2 Dr Letter 25" Deep	10 ³ / ₁₆ "	12 ¹ / ₁₆ "	19 ³ / ₄ "	27 ³ / ₄ "	17 ³ / ₄ "	25 ¹ / ₁₆ "	320 lbs.
	2-2125-C	2 Dr Legal 25" Deep	10 ³ / ₁₆ "	15 ¹ / ₄ "	19 ³ / ₄ "	27 ³ / ₄ "	20 ¹³ / ₁₆ "	25 ¹ / ₁₆ "	341 lbs.
	<i>FireKing 25: Series available in black, sand, parchment and platinum only. Lock accessories not available on FireKing 25.</i>								
FIREKING TURTLE	4R1822-C	4 Drawer Vertical	10 ³ / ₁₆ "	12 ¹ / ₁₆ "	15 ¹ / ₁₆ "	52 ¹ / ₁₆ "	17 ³ / ₄ "	22 ¹ / ₁₆ "	468 lbs.
	2R1822-C	2 Drawer Vertical	10 ³ / ₁₆ "	12 ¹ / ₁₆ "	15 ¹ / ₁₆ "	27 ³ / ₄ "	17 ³ / ₄ "	22 ¹ / ₁₆ "	268 lbs.
	<i>Turtles: A space-saving file 22" deep that holds letter-size hanging folders front-to-back and legal-size hanging folders side-to-side. Turtles are available in parchment only. Turtle files are equipped with four-pin key lock only. Lock accessories not available on Turtle files.</i>								
FIREKING CARD, CHECK AND NOTE FILES	6-2552-C	6 Drawer	6 ¹ / ₄ "	19 ³ / ₄ "	26"	52 ¹ / ₁₆ "	25 ⁵ / ₁₆ "	31 ¹ / ₁₆ "	943 lbs.
	4-2536-C	4 Drawer	6 ¹ / ₄ "	19 ³ / ₄ "	26"	36 ¹ / ₃₂ "	25 ⁵ / ₁₆ "	31 ¹ / ₁₆ "	742 lbs.
MEDIAVAULT	MV1000		5 ⁷ / ₈ "	6 ¹ / ₄ "	8 ⁷ / ₈ "	10 ¹ / ₂ "	11 ⁵ / ₈ "	17 ¹ / ₂ "	74 lbs.
	<i>FireKing Card, Check & Note: Storage for specially sized records.</i>								
	<i>Underwriters Laboratories® and UL® are registered trademarks of Underwriters Laboratories and are used with permission.</i>								

COLORS

FireKing vertical, lateral, and Card, Check and Note files are available in the nine standard colors preferred by today's office designers and decorators: parchment, champagne, tan, sand, platinum, brown, taupe, pewter, and black.

FireKing 25 files are available in parchment, platinum and black.

Turtle files are available in parchment only.

To aid your selection, your FireKing dealer will be glad to show you color chips. Custom colors are also available.



Custom colors are also available.

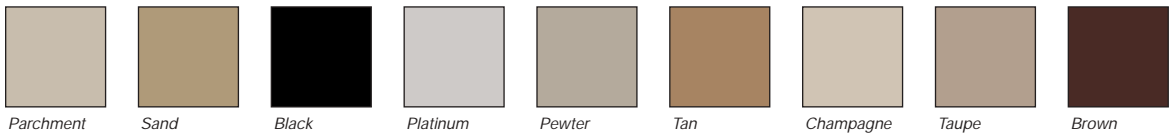

FILE FEATURES

FIREPROOF INSULATION
is 100% gypsum, reinforced by a 1"x2" lattice made of 14-gauge, galvanized welded-steel wire, providing complete peace of mind from fire, impact, or explosion.

FIELD-REPLACEABLE STEEL PANELS
In the event that any panel is damaged, it can be easily replaced.

FINISH is an environmentally friendly, electrostatic powder coating, applied to all sides, including bottom. The finish is scratch-resistant, providing a lifetime quality appearance.

DRAWER BODIES are built with high sides for use with hanging folders—no additional frames are required.

DRAWER SUSPENSIONS are maintenance-free and guaranteed for life.

DRAWER LOCKS on all files provide general locking of all drawers through either standard key locks or UL-listed, high-security locks.

DRAWER PULLS are surface-mounted to allow for extra insulation inside the drawer heads.

INSULATION BETWEEN ALL DRAWERS makes each one a separate insulated container.

TWO-POSITION DRAWER CATCH allows access to certain drawers while others remain locked.

DRAWER HEADS are formed of welded steel and filled with fireproof gypsum insulation.





2.000

0.031

1.58

1.807

26.003

23.594

CLEAR

.224

BACKPLATE FLAME

.312

Security

Where do you store your vital papers and records? How do you protect your computer media? How do you protect your personal valuables?



FIREKING SAFES MEAN PROTECTION.

For nearly 50 years, forward-thinking businesses and individuals have relied on Fire King International to safeguard their vital records, documents, securities and computer media. By choosing FireKing safes, you too can experience the peace of mind protection brings.

FireKing safes come in an extensive range of styles, sizes, and budgets. So you can be assured of finding a quality safe to meet your needs. For those who need only to protect documents or vital records, our 1-Hour Fire-Rated Series is an economical solution. Each of these safes carries Underwriters Laboratories UL Class 350 1-hour fire rating, along with basic theft protection features.

If you'd like additional fire protection, choose from our affordable 2-Hour Fire with Impact Rated Series. Each of these safes carries a UL Class 350 2-hour fire rating, plus a UL impact rating, which assures you protection in case of ceiling or floor collapse.

For enhanced burglary protection, there are the FireKing 1-Hour Fire and Burglary safes. These safes were the first to earn both a UL Class 350 1-hour fire rating and a UL Residential Security Container (RSC) burglary rating from Underwriters Laboratories.

To meet the extraordinary needs of businesses where sustained fire is a risk, we offer 2-Hour Fire with Impact and Burglary safes, offering a superior level of protection against fire and theft. All of these safes carry the UL 2-hour fire and impact label, plus the RSC burglary rating.

We also offer a range of FireKing Data Safes designed to protect sensitive magnetic storage media from heat, humidity, dust and magnetic fields. All carry a UL Class 125 1- and 2-hour fire and impact rating. These range from our compact mid-size Data Safes to our spacious high-capacity Data Safes. Select the model that fits your storage protection needs.

All come standard with an electronic lock and bolt-down capabilities.



FK1613-1



KV2015-2

One of three sizes featuring seamless body construction. Vinyl feet prevent scratching.

FIREKING 1-HOUR RATED FIRE SAFES

Model	Interior Size			Exterior Size			Weight	Capacity
	H	W	D	H	W	D		
FK1313-1	13"	13"	10"	17 $\frac{1}{8}$ "	16 $\frac{1}{8}$ "	16 $\frac{1}{4}$ "	95 lbs.	1.0 cu. ft.
FK1613-1	16"	13"	12 $\frac{1}{2}$ "	21"	17"	18 $\frac{1}{2}$ "	135 lbs.	1.5 cu. ft.
FK1714-1	16 $\frac{1}{8}$ "	13 $\frac{1}{2}$ "	15"	23"	18 $\frac{3}{8}$ "	20 $\frac{1}{8}$ "	205 lbs.	2.0 cu. ft.

FIREKING 2-HOUR FIRE- AND IMPACT-RATED SAFES

KV1714-2	16 $\frac{1}{8}$ "	13 $\frac{1}{2}$ "	12"	23"	18 $\frac{3}{8}$ "	20"	250 lbs.	1.6 cu. ft.
KV2015-2	20"	15"	13 $\frac{1}{4}$ "	26"	20"	21 $\frac{1}{4}$ "	325 lbs.	2.3 cu. ft.

See your dealer for the complete selection of interior designs.

UL 1-HOUR FIRE SAFES

Designed to provide economical, but uncompromised fire protection for important documents, this series carries a UL Class 350 1-hour fire rating with an electronic lock, offering excellent fire protection and basic theft security. Available in three sizes, in graphite color only.

PROTECTS DOCUMENTS FOR AT LEAST ONE HOUR IN TEMPERATURES UP TO 1700°

These FireKing safes carry the UL Class 350 1-hour fire rating. This means that the internal temperature of the safe will not exceed 350° for at least one hour when exposed to external temperatures up to 1700°. This exhaustive testing proves FireKing safes are built to survive the worst conditions.

UL 2-HOUR WITH IMPACT FIRE SAFES

These are premium home and small office record safes, offering enhanced durability and protection. These economical safes feature a full UL Class 350 2-hour fire rating with impact with an electronic lock. Heavy-duty hinges offer smooth door operation for the life of the safe.

These safes provide important security features such as 3-way boltwork and a UL-listed relocking device with an integrated door hardplate. They offer you complete peace of mind for your important personal documents, at a most affordable price. Available in two sizes, in graphite color only.



FB5428-1
Shown in graphite with optional electronic lock

Comes standard with four shelves.



FB1612-1
Shown in taupe with optional electronic lock

**FIREKING 1-HOUR
FIRE- AND BURGLARY-
RATED SAFES**

Model	Interior Size			Exterior Size			Weight	Capacity
	H	W	D	H	W	D		
FB1612-1	16"	12"	12 ¹ / ₄ "	21 ¹ / ₆ "	17 ¹³ / ₆ "	21 ¹ / ₈ "	280 lbs.	1.3 cu. ft.
FB2218C1	22"	18 ⁵ / ₈ "	12 ¹ / ₄ "	27 ⁵ / ₆ "	24 ¹ / ₆ "	21 ⁵ / ₈ "	430 lbs.	3.8 cu. ft.
FB2218-1	22"	18 ⁵ / ₈ "	16"	27 ⁵ / ₆ "	24 ¹ / ₆ "	25 ¹ / ₄ "	450 lbs.	3.8 cu. ft.
FB3020-1	30"	20"	21"	35 ⁵ / ₆ "	29 ¹³ / ₆ "	30 ¹ / ₄ "	670 lbs.	7.3 cu. ft.
FB3624-1	36"	24"	21"	41"	29 ¹³ / ₆ "	30 ¹ / ₄ "	835 lbs.	12.0 cu. ft.
FB4524-1	45"	24"	21"	50 ¹ / ₆ "	29 ¹³ / ₆ "	30 ¹ / ₄ "	1,050 lbs.	15.0 cu. ft.
FB5428-1	54 ³ / ₄ "	28 ⁵ / ₆ "	19 ¹ / ₈ "	60 ⁵ / ₆ "	34 ¹ / ₆ "	29 ¹ / ₈ "	1,116 lbs.	18.0 cu. ft.

See your dealer for the complete selection of interior designs.

UL 1-HOUR FIRE AND BURGLARY SAFES

These safes carry both a UL Class 350 1-hour fire rating and a UL RSC burglary rating. You might expect to pay hundreds, even thousands more for a safe so tough. However, using today's most advanced technology, FireKing is able to offer these dual-labeled safes at a very affordable price. You don't have to sacrifice protection or pay more for the security they offer. Available in seven sizes and two colors, graphite or taupe.

FEATURES:

- UL-listed relocking device for extra security
- Drill-resistant steel hardplate protects the combination lock
- Vertical and horizontal bolts resist prying
- Bolt-O-Matic door guard automatically extends the 1" bolts when the door is closed
- UL-rated Group II combination lock is standard with over 1,000,000 combinations
- Optional Sargent & Greenleaf electronic lock automatically locks safe when door is closed



KR2115-2
Shown in graphite with optional electronic lock

Equipped with two standard adjustable shelves and extra hardplate for enhanced drill resistance. All have a UL fire and impact label, a UL RSC burglary label and a high-security Medeco key lock.



KR5021-2
Shown in taupe with optional electronic lock

Three shelves are standard as well as a 7/8" anchor hole in the bottom of the safe.

**FIREKING 2-HOUR
FIRE WITH IMPACT
AND BURGLARY-RATED
RECORD SAFES**

Model	Interior Size			Exterior Size			Weight	Capacity
	H	W	D	H	W	D		
KR2115-2	20"	18½"	15"	30⅞"*	25½"	22⅞"	420 lbs.	3.2 cu. ft.
KR2021-2	20"	18½"	21"	30⅞"*	25½"	28⅞"	560 lbs.	4.5 cu. ft.
KR3115-2	30⅞"	18½"	15"	41⅞"*	25½"	22⅞"	525 lbs.	4.9 cu. ft.
KR3121-2	30⅞"	18½"	21"	41⅞"*	25½"	28⅞"	635 lbs.	6.9 cu. ft.
KR3921-2	39½"	18½"	21"	49⅞"*	25½"	28⅞"	760 lbs.	8.9 cu. ft.
KR5021-2	50"	18½"	21"	60⅞"*	25½"	28⅞"	875 lbs.	11.2 cu. ft.

*Includes 1" for feet.
See your dealer for the complete selection of interior designs.

UL 2-HOUR FIRE WITH IMPACT AND BURGLARY SAFES

If you have reason to be extraordinarily serious about security, FireKing 2-Hour Fire and Burglary safes are perfect for you. They are designed to offer superior fire and burglary protection. All six sizes carry a UL Class 350 2-hour fire rating, and all have passed UL's impact test.* All meet stringent security testing and carry a UL RSC burglary label and a UL-listed relocker. Available in six sizes and two colors, graphite or taupe.

*The UL impact test calls for the safe to be heated to 1550° for 30 minutes (1638° for 45 minutes for a 2-hour fire-rated safe) then dropped onto concrete rubble from a height of 30 feet. Then it is inverted and reheated for another 30 minutes (45 minutes for a 2-hour fire-rated safe). The safe must maintain its integrity throughout the test and protect all contents. Why is impact testing important? In many fires, roofs will cave in or the floor will collapse, destroying everything under them. In such an event, you'll want to know your safe is impact-rated.

Underwriters Laboratories® and UL® are registered trademarks of Underwriters Laboratories and are used with permission.

FIREKING MIXED MEDIA SAFE



Safe shown with optional interiors sold separately.

CAPACITY GUIDE

Media Type	DP2150-M
3.5" Diskettes	
Quantity per Drawer	536
Number of Fittings	6
3480 IBM Cartridges	
Quantity per Drawer	51
Number of Fittings	4
4mm DAT	
Quantity per Drawer	125
Number of Fittings	7
8mm DAT	
Quantity per Drawer	72
Number of Fittings	7
CD-ROM	
Quantity per Drawer	123
Number of Fittings	4
DLT Tapes	
Quantity per Drawer	42
Number of Fittings	5
Zip disk 100	
Quantity per Drawer	128
Number of Fittings	5

Capacity guides are based on average media sizes.

**MEDIA COMPARTMENT
OPTIONAL INTERIORS**

- CM19-FS Fixed shelf
- CM19-CD Composite drawer

**PAPER COMPARTMENT
OPTIONAL INTERIORS**

- S-21 Fixed shelf

SPECIFICATIONS

Model	Interior Size			Exterior Size			Weight	Capacity
	H	W	D	H	W	D		
DP2150-M				59 ³ / ₄ "	32 ¹ / ₁₆ "	31"	1,290 lbs.	
Paper compartment	19 ¹ / ₂ "	26 ³ / ₄ "	20 ²⁹ / ₃₂ "					6.1 cu. ft.
Media compartment	24 ⁵ / ₁₆ "	18 ⁵ / ₁₆ "	16 ¹¹ / ₁₆ "					4.4 cu. ft.

*Exterior depth does not include handle.
Handle depth is 1³/₄"

FIREKING
MIXED MEDIA SAFE

FIREKING MIXED MEDIA SAFE

The Mixed Media Safe from FireKing offers the ultimate in versatile protection – because it's really two safes in one. The top section is a UL® Class 350 1-Hour Impact Rated safe with over 6 cubic feet of storage for your important paper records and files. The bottom is a UL Class 125 3-Hour Impact Rated data media compartment to hold your CDs, tapes, discs and other media.



FIREKING 3-HOUR DATA SAFE



Safe shown with Composite Drawers and Fixed Shelves (sold separately).

CAPACITY GUIDE

Media Type	DM1413-3	DM2513-3	DM2520-3	DM3420-3	DM4420-3
3.5" Diskettes					
Quantity per Drawer	306	306	536	536	536
Number of Fittings	3	6	6	8	10
3480 IBM Cartridges					
Quantity per Drawer	28	28	51	51	51
Number of Fittings	2	4	4	6	8
4mm DAT Tapes					
Quantity per Drawer	70	70	125	125	125
Number of Fittings	4	7	7	10	13
8mm DAT Tapes					
Quantity per Drawer	39	39	72	72	72
Number of Fittings	4	7	7	10	13
CD ROM					
Quantity per Drawer	70	70	123	123	123
Number of Fittings	2	4	4	5	7
DLT Tapes					
Quantity per Drawer	24	24	42	42	42
Number of Fittings	2	5	5	6	8
ZIP® PC 100					
Quantity per Drawer	73	73	128	128	128
Number of Fittings	3	5	5	7	9

Capacity guides are based on average media sizes.

TEST PROCEDURE

*Maintain an interior temperature less than 125°F and an interior relative humidity less than 80% for class 125, when exposed to fire as per the Standard Time Temperature Curve for 3 hours to 1925°. Successfully undergo all other requirements for the Fire Endurance Test, the Explosion Hazard Test, the Humidity Test and the Fire and Impact Test.

OPTIONAL INTERIORS

- CM12-FS Fixed shelf for DM1413/DM2513
- CM12-CD Composite Drawer for DM1413/DM2513
- CM19-FS Fixed shelf for DM2520/DM3420/DM4420
- CM19-CD Composite Drawer for DM2520/DM3420/DM4420

SPECIFICATIONS

Model	Interior Size			Exterior Size			Weight	Capacity
	H	W	D	H	W	D		
DM1413-3	13 ⁵ / ₈ "	11 ¹ / ₂ "	16 ¹¹ / ₁₆ "	29 ⁵ / ₈ "	25 ¹ / ₄ "	31"	650 lbs.	1.5 cu. ft.
DM2513-3	24 ⁵ / ₁₆ "	11 ¹ / ₂ "	16 ¹¹ / ₁₆ "	40 ¹ / ₄ "	25 ¹ / ₄ "	31"	740 lbs.	2.7 cu. ft.
DM2520-3	24 ¹⁹ / ₁₆ "	18 ⁵ / ₈ "	16 ¹¹ / ₁₆ "	40 ¹ / ₄ "	32 ¹ / ₁₆ "	31"	1,050 lbs.	4.4 cu. ft.
DM3420-3	33 ¹ / ₈ "	18 ⁵ / ₈ "	16 ¹¹ / ₁₆ "	49 ¹ / ₈ "	32 ¹ / ₁₆ "	31"	1,240 lbs.	6.0 cu. ft.
DM4420-3	43 ⁵ / ₈ "	18 ⁵ / ₈ "	16 ¹¹ / ₁₆ "	59 ³ / ₄ "	32 ¹ / ₁₆ "	31"	1,420 lbs.	7.9 cu. ft.

*Exterior depth does not include handle.
Handle depth is 1³/₄"

FIREKING 3-HOUR FIRE WITH IMPACT-RATED DATA SAFES

FIREKING 3-HOUR FIRE WITH IMPACT-RATED DATA SAFES

The FireKing 3-Hour Fire With Impact-Rated Data Safes provide the ultimate in protection against fire, dust, electrostatics and accidental damage for your computer media. They're our highest rated safes and are perfect for businesses with large-capacity electronic storage needs. FireKing 3-Hour Data Safes are available in five sizes, all featuring the UL Class 125 3-hour fire and impact rating*, plus the UL Residential Security Container (RSC) Burglary Rating for tough protection against break-in.

FEATURES

- Programmable electronic lock for security and easy access
- Safe is offered in our attractive Platinum finish
- UL RSC Burglary Rating
- UL Class 125 3-Hour fire and impact rating
- Canadian UL Class 52 3-Hour as to fire and impact resistance



FIREKING 2-HOUR DATA SAFE



CAPACITY GUIDE

Media Type	DS2319	DS4319	DS6119	DS5337
3.5" Diskettes				
Quantity per Drawer	532	532	532	1024
Number of Fittings	5	10	15	13
3480 IBM Cartridges				
Quantity per Drawer	51	51	51	102
Number of Fittings	4	8	12	10
4mm DAT Tapes				
Quantity per Drawer	124	124	124	225
Number of Fittings	5	10	15	21
8mm DAT Tapes				
Quantity per Drawer	68	68	68	123
Number of Fittings	5	10	15	18
CD ROM				
Quantity per Drawer	115	115	115	205
Number of Fittings	3	7	10	10
DLT Tapes				
Quantity per Drawer	42	42	42	87
Number of Fittings	4	9	13	12
ZIP® PC 100				
Quantity per Drawer	127	127	127	231
Number of Fittings	5	9	14	12

Capacity guides are based on average media sizes.

OPTIONAL INTERIORS

- CS18-FS Fixed shelf for DS2319/4319/6119-2
- CS18-CD Composite drawer for DS2319/4319/6119-2
- CS36-FS Fixed shelf for DS5337-2
- CS36-CD Composite drawer for DS5337-2

TEST PROCEDURE

*Maintain an interior temperature less than 125°F and an interior relative humidity less than 80% for class 125, when exposed to fire as per the Standard Time Temperature Curve for 2 hours to 1850°F. Successfully undergo all other requirements for the Fire Endurance Test, the Explosion Hazard Test, the Humidity Test and the Fire and Impact Test.

Safe shown with Composite drawers and fixed shelves (sold separately).

SPECIFICATIONS

Model	Interior Size			Exterior Size			Weight	Capacity
	H	W	D	H	W	D		
DS2319-2LG	23 ³ / ₁₀ "	18 ⁷ / ₁₀ "	16 ¹ / ₈ "	39 ¹ / ₈ "	33"	31 ¹ / ₁₀ "	968 lbs.	4.0 cu. ft.
DS4319-2LG	43 ¹ / ₁₀ "	18 ¹ / ₁₀ "	16 ¹ / ₈ "	59"	33"	31 ¹ / ₁₀ "	1,485 lbs.	7.5 cu. ft.
DS6119-2LG	61 ¹ / ₁₀ "	18 ¹ / ₁₀ "	16 ¹ / ₈ "	77 ¹ / ₈ "	33"	31 ¹ / ₁₀ "	1,773 lbs.	10.6 cu. ft.
*DS5337-2LG	53 ¹ / ₁₀ "	36 ¹ / ₈ "	16 ³ / ₁₀ "	70 ¹ / ₁₀ "	49 ¹ / ₈ "	29 ¹ / ₁₀ "	1,870 lbs.	18.0 cu. ft.

See your dealer for the complete selection of interior designs.

**Not UL rated.*

FIREKING 2-HOUR FIRE WITH IMPACT-RATED DATA SAFES

FIREKING 2-HOUR FIRE WITH IMPACT-RATED DATA SAFES

The FireKing 2-Hour Fire With Impact-Rated Data Safe provides an ideal way to store all types of magnetic media and protects them against fire, dust and accidental damage. They are available in four sizes to accommodate your storage needs. These affordable safes provide the ultimate in protection by incorporating layers of heat-absorbing material, fireproof insulating foam and fireproofing with a tough steel casing. Three-way boltwork ensures that doors remain shut if a building collapses during a fire or if a forced entry is attempted. Each FireKing 2-Hour safe carries a UL Class 125 2-hour fire and impact rating*.

FEATURES:

- Equipped with a high-security key lock
- Safe is offered in our attractive light gray color (RAL9002)
- Optional interiors allow various configurations to meet your storage needs

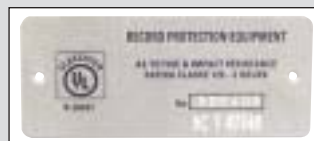

FIREKING 1-HOUR DATA SAFE



TEST PROCEDURE

*Maintain an interior temperature less than 125°F and an interior relative humidity less than 80% for class 125, when exposed to fire as per the Standard Time Temperature Curve for 1 hour to 1700°F. Successfully undergo all other requirements for the Fire Endurance Test, the Explosion Hazard Test, the Humidity Test and the Fire and Impact Test.

Safe shown with Composite drawers and fixed shelves (sold separately)

CAPACITY GUIDE

Media Type	DS1513-LG	DS1817-LG
3.5" Diskettes		
Quantity per Drawer	264	480
Number of Fittings	3	4
3840 IBM Cartridges		
Quantity per Drawer	26	45
Number of Fittings	2	3
4mm DAT Tapes		
Quantity per Drawer	60	108
Number of Fittings	3	4
8mm DAT Tapes		
Quantity per Drawer	32	63
Number of Fittings	3	4
CD ROM		
Quantity per Drawer	58	108
Number of Fittings	2	3
DLT Tapes		
Quantity per Drawer	18	39
Number of Fittings	3	3
ZIP® PC 100		
Quantity per Drawer	58	111
Number of Fittings	3	4

Capacity guides are based on average media sizes.

OPTIONAL INTERIORS

CS12-FS	Fixed shelf for DS15130-1
CS12-CD	Composite drawer for DS1513-1
CS16-FS	Fixed shelf for DS1817-1
CS16-CD	Composite drawer for DS1817-1

SPECIFICATIONS

FIREKING 1-HOUR FIRE WITH IMPACT-RATED DATA SAFES

Model	Interior Size			Exterior Size			Weight	Capacity
	H	W	D	H	W	D		
DS1513-1LG	14 $\frac{3}{8}$ "	12 $\frac{7}{16}$ "	12 $\frac{7}{16}$ "	25 $\frac{1}{2}$ "	21 $\frac{1}{2}$ "	22 $\frac{3}{8}$ "	297 lbs.	1.3 cu. ft.
DS1817-1LG	17 $\frac{1}{2}$ "	16 $\frac{1}{2}$ "	17"	28 $\frac{3}{8}$ "	25 $\frac{1}{2}$ "	26 $\frac{3}{8}$ "	429 lbs.	2.8 cu. ft.

FIREKING 1-HOUR FIRE WITH IMPACT-RATED DATA SAFES

The FireKing 1-Hour Fire With Impact-Rated Data Safe has a wide range of interiors for storing magnetic media, making it a versatile and economical choice. Computer media is easily damaged. Manufacturers recommend storing magnetic media at a temperature below 125°F and at a humidity level under 80%. Even a hot mug of coffee represents a real hazard, so imagine what a fire would do. In a FireKing Data Safe, computer media is protected from fire, dust, magnetic fields, unauthorized access, accidental damage and electrostatic discharge. The 1-Hour Data Safe comes in two convenient sizes, DS1513 and DS1817, and both carry a UL Class 125 1-hour fire and impact rating.*

FEATURES:

- Equipped with a high-security key lock
- Safe is offered in our attractive light gray color (RAL9002)



FIREKING MEDIAVAULT™



FireKing 1-Hour UL Class 125 Fire Rating.

CAPACITY GUIDE

Media Type	MV1000
3.5" Diskettes	130
5.25" Diskettes	120
4mm DAT	60
DC 2000/2120	32
8mm DAT	30
Travan	23
CD-ROM	23
*DLT	12
3480/3590	9
Zip disk 100	31

**Without plastic sleeves.*

SPECIFICATIONS

Model	Interior Size			Exterior Size			Weight
	H	W	D	H	W	D	
MV1000	5½"	6¼"	8¾"	10½"	11½"	17½"	74 lbs.

THE COMPACT, STAND-ALONE FIREKING MEDIAVAULT PROVIDES SECURITY, CONVENIENCE AND PEACE OF MIND.

The MediaVault from FireKing is a compact, affordable stand-alone storage safe that is designed to protect heat-sensitive valuables, including data and information storage media. Whether it's microfiche, photographs or computer data on virtually any standard media (see chart above), the MediaVault will protect it from dust and fires of up to 1700°F.

The MediaVault is the only compact and affordable media safe of its size designed to meet Underwriters Laboratories (UL) Class 125, one-hour specification for insulated record protection equipment. This specification

ensures that the interior temperature of the storage device does not exceed 125°F when exposed to a fire of 1700°F for a period of one hour and during that time the interior relative humidity does not exceed 85%RH.

The MediaVault is equipped with a key lock conveniently located on the lid for added security.

PEACE OF MIND



THE BEST RECORDS PROTECTION YOU CAN BUY

Fire King® International, Inc.

101 Security Parkway

New Albany, Indiana 47150

812-948-8400/800-457-2424 • Fax: 812-948-0437/800-227-7513

E-mail: fireking@fireking.com • website: www.fireking.com

A member of the FKI® Security Group

Fire King International, Inc.
is ISO 9001:2000 Certified Company